

## CLB 2.65 25A

- Used to sense the current load of a medical insulated power supply system, which is monitored by the insulation monitoring device from HAKEL.
- Available in the range of primary current 25 A to 100 A, secondary current 5 A.
- Construction is pluggable, is supplied in two dimensional versions, depending on the primary current.
- Designed for installation in an IPS panel, they can be mounted to the distribution board using reduction brackets (included), or using a DIN rail bracket (must be purchased separately).
- Alternatively, the transformer can be mounted directly on the copper profile, up to a maximum size of 20 x 10 mm.
- Work reliably with HAKEL HIG95-DELTA and HIG95+ insulation monitoring devices.

Type		CLB 2.65 25A
Primary current		25 A
Secondary side current		5 A
Power	P	1 W
Accuracy class		3
Overcurrent number (FS)		5
Transformer construction		Pluggable (without interrupting the primary conductor)
Frequency	f	50 ÷ 60 Hz
Housing material		Self-extinguishing
Recommended cross-section of connected conductors	S	1.5 ÷ 2.5 mm <sup>2</sup>
Operating position		Any
Operating temperature	θ	-25 ÷ 40 °C
Article number of DIN rail bracket		71 541
<b>Designed according to standards</b>		
Instrument transformers – General requirements		IEC 61869-1:2007
Instrument transformers – Additional requirements for current transformers		IEC 61869-2:2012
<b>Application standards</b>		
Low-voltage electrical installations – Medical locations		HD 60364-7-710:2012
Insulation monitoring devices for medical locations (MED-IMD)		IEC 61557-8:2014 annex A
<b>Ordering, packaging and additional data</b>		
Mass	m	646 g
Mass (including the packaging)	m	674 g
Packaging dimensions (H x W x D)		74 x 112 x 73 mm
Packaging value	V	0.61 dm <sup>3</sup>
Customs tariff no.		85043129
EAN code		8590681270882
<b>Art. number</b>		<b>71 530</b>



The link in the QR code leads to the online presentation of the **CLB 2.65 25A**. There, in addition to the always up-to-date data sheet, you will also find all diagrams and drawings, declarations of conformity, or 2D or 3D models and other necessary materials. For more information, visit [www.hakel.com](http://www.hakel.com)



## Application wiring diagram (installation)

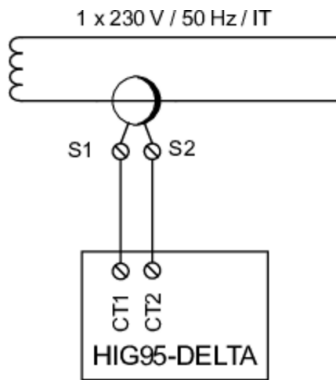

## Internal diagram

