

## HSA-75/3+0 S

- Surge arresters type T2+T3 ensure the equipotential bonding and reduce switching, induced and residual overvoltage in LV power supply systems.
- The products consist of varistors with big discharge ability.
- Configurations 1+1 and 3+1 are additionally combined with a gas discharge tube which ensures zero leakage current through the PE conductor.
- Installed at the boundaries of LPZ 1 – LPZ 3 into subsidiary switchboards and control panels.
- If the product contains two PE (or PEN) terminals, it must not be used as a PE (PEN) bridge.
- **M** indication specifies a type of construction with removable module.
- **S** indication specifies a version with remote monitoring.

Type		HSA-75/3+0 S
Test class according to EN 61643-11:2012 (IEC 61643-11:2011)		T2, T3
System		TN-C
Number of poles		3
Rated operating AC voltage	$U_N$	60 V
Maximum continuous operating voltage AC	$U_C$	75 V
Maximum discharge current (8/20)	$I_{max}$	40 kA
Nominal discharge current for class II test (8/20)	$I_n$	15 kA
Open circuit voltage of the combination wave generator	$U_{OC}$	6 kV
Total discharge current (8/20) L1+L2+L3->PEN	$I_{Total}$	120 kA
Voltage protection level at $I_n$	$U_p$	< 0.4 kV
Voltage protection level at $U_{OC}$	$U_p$	< 0.3 kV
Temporary overvoltage test (TOV) for $t_T = 5$ s	$U_T$	91 V
Temporary overvoltage test (TOV) for $t_T = 120$ min	$U_T$	104 V
Response time	$t_A$	< 25 ns
Maximal back-up fuse		160 A gL/gG
Residual current	$I_{PE}$	≤ 600 μA
Short-circuit current rating at maximum back-up fuse	$I_{SCCR}$	60 kA <sub>rms</sub>
Lightning protection zone		LPZ 1-2, LPZ 2-3
Housing material		Polyamid PA6, UL94 V-0
Degree of protection		IP20
Operating temperature	$\vartheta$	-40 ÷ 70 °C
Humidity range	RH	5 ÷ 95 %
Minimum cross-section of connected Cu conductors accord. to HD 60364-5-53:2022 (doesn't apply to „V“ connection) for T2	S	2.5 mm <sup>2</sup> (L, N) 6 mm <sup>2</sup> (PE, PEN)
Clamp fastening range (solid conductor)		1.5 ÷ 25 mm <sup>2</sup>
Clamp fastening range (stranded conductor)		1.5 ÷ 16 mm <sup>2</sup>
Tightening moment		3 Nm
Installation		On DIN rail 35 mm
Modular width		3 TE

Type		HSA-75/3+0 S
Operating position		Any
Product placement environment		Internal
Signalling at the device		Optic
Importance of local signalling		OK – clear target FAULT – red target
Remote signalling		Yes
Potential free signal contact (S) (recommended cross-section of remote monitoring max. 1 mm <sup>2</sup> )		AC: 250 V / 1.5 A, DC: 250 V / 0.1 A
Modular design		No
Lifetime		> 100 000 h
<b>Designed according to standards</b>		
Requirements and test methods for SPDs connected to low-voltage power systems		IEC 61643-11:2011
Safety of Flammability of Plastic Materials		UL 94
<b>Application standards</b>		
Protection against lightning		IEC 62305:2010
Selection and erection of electrical equipment – Switchgear and controlgear		HD 60364-5-53:2022
Selection and application principles for SPDs connected to low-voltage power systems		CLC/TS 61643-12:2009
<b>Ordering, packaging and additional data</b>		
Mass	m	267 g
Mass (including the packaging)	m	291 g
Packaging dimensions (H x W x D)		60 x 113 x 73 mm
Packaging value	V	0.5 dm <sup>3</sup>
ETIM group		EG000021
ETIM class		EC000941
Customs tariff no.		85363010
EAN code		8590681114971
<b>Art. number</b>		<b>24 510</b>



The link in the QR code leads to the online presentation of the HSA-75/3+0 S. There, in addition to the always up-to-date data sheet, you will also find all diagrams and drawings, declarations of conformity, or 2D or 3D models and other necessary materials. For more information, visit [www.hakil.com](http://www.hakil.com)



**Application wiring diagram (installation)**

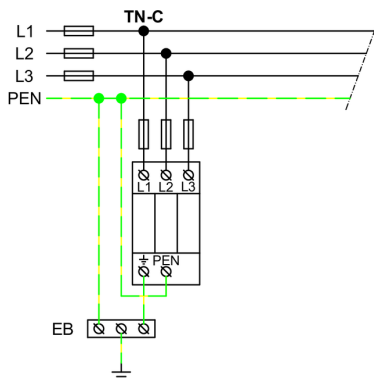

**Internal diagram**

